



HOME-ESS-LV-5.12K

Quick Installation Guide

Version 02



Android APP



iOS APP

1. Installation Precautions

Flow chart of installation steps:

Please follow the equipment installation steps process to ensure the equipment can be successfully installed.

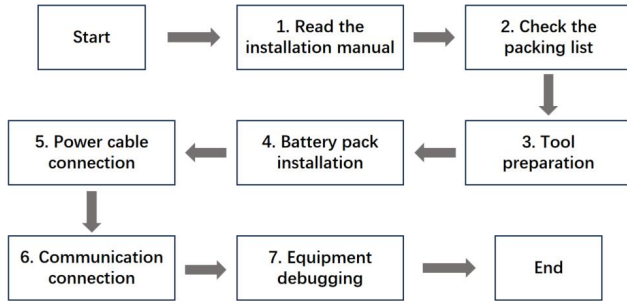

Please ensure that the installer meets the following requirements:

This system should only be installed by personnel with training and adequate knowledge of electrical power systems.

Please ensure that the installation location meets the following conditions:

- The installation and operational environment need to comply with local laws and regulations and relevant international national and regional standards for lithium battery products.
- Install in a dry, well-ventilated environment and secure the equipment on a sturdy and horizontal support surface.
- Avoid water accumulation in the installation location and keep away from water sources such as faucets, sewer pipes, and sprinklers. to avoid water infiltration.
- The environment around the installation location is clean. There is no infrared radiation, heat source, conductive dust, organic solvents, corrosive gases, etc.
- When the equipment is running, the temperature of the under-frame and heat sink will be relatively high, please do not install it in a place where it is easy to be touched.
- When the equipment is running, do not block the ventilation openings or cooling system to prevent high-temperature fires.
- Please choose a sheltered installation site or build an awning to avoid direct sunlight or rain.

Schematic diagram of battery interface:

The definition of each interface must be clear during the installation process, otherwise the wrong connection will lead to installation failure or even damage to the equipment.

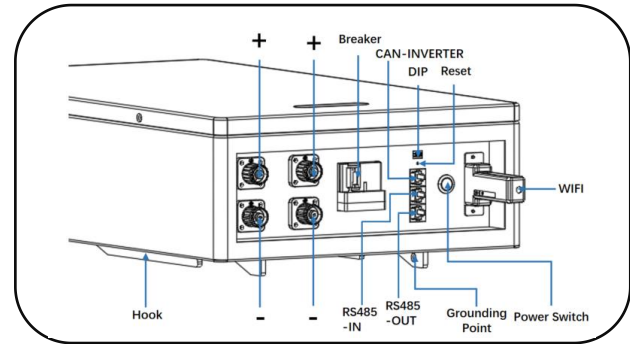

2. Check the Packing List

Please refer to the packing items shown below, please check the packing list carefully, if any items are missing, please contact your dealer directly.

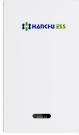

Battery



BAT-Logger



Wall mount bracket



Quick Installation Guide



RS485 communication
line/800mm



CAN communication
line/1000mm



Power cable 1 Black/800mm



Power cable 2 Red/800mm



Power cable 3 Black/1000mm



Power cable 4 Red/1000mm



Expansion bolt * 4



Ground screw and Spare terminal
OT6-4/M4*8/SC25-8 *2

3. Tool preparation

Step 1: Protective equipment products must be worn and maintained during the installation process.



Safety gloves



Safety glasses



Safety shoes

Step 2: Installation Tools: tools needed in the process of installing equipment, more effective to improve installation efficiency.



Phillips screw driver



Hammer



Torque screw driver



Ruler



Electric driver



Marker pen

4. Battery Pack Installation

Attention should be paid to the following items before installation:

- **Power cable specification:** The matching power cable is 3AWG, and the max carrying capacity is 200A. Please do not work under the condition of exceeding this current.
- **Mounting space:** Make sure that the battery system has enough space to install, make sure the wall is strong enough to bear the weight of the battery system. Installing on a solid cement wall with a thickness of not less than 100mm is recommended.
- **Wiring:** Make sure the power cable and ground wire are reasonable. Not easy to short-circuit, water and corrosion.

Wall Installation:

Step 1: Locate drill holes in the wall

Use the bracket as a template to make positioning holes in the wall, mark the positions of the 4 holes, and then drill 10mm holes to ensure that the depth of the holes is greater than 50mm. The bracket should be placed at least 550mm above the ground.

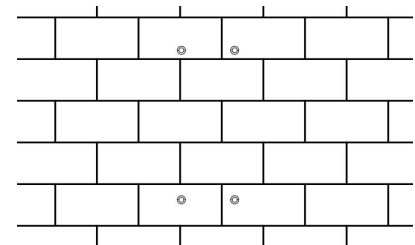
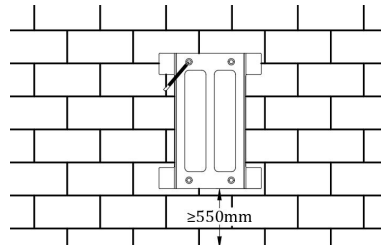

Step 2: Fix the wall mount bracket

Fit the expansion tubes into the holes, pull them tight, and then use the expansion screws (packaged with expansion tube for use) to install and secure the wall mount bracket to the wall.

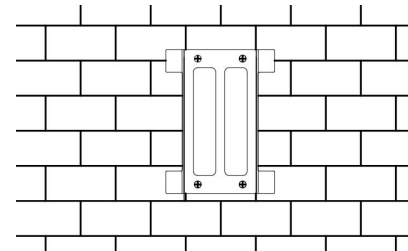
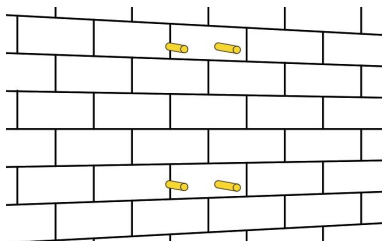

Step 3: Fix the battery module

There is a hook design on the back of the battery box, align and fix it to the positioning groove of the wall bracket for firm support. The distance between the batteries is 300-350mm, and the distance between the battery and the inverter is not less than 400mm.

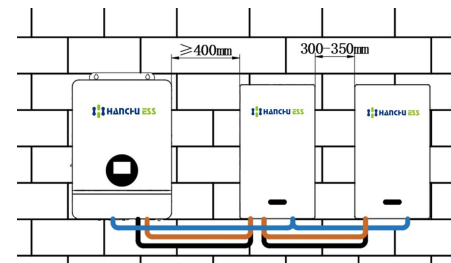

5. Power cable connection

Installation Preparation:

Before connecting cables, make sure the battery and inverter are entirely switched off. Make sure all breaker switches are fully switched off.

Before connecting the power cables, use a multimeter to measure cable continuity, short circuits, and confirm positive and negative.

Step 1: Connect the battery ground cable

The area of the grounding cable shall be prepared at least 6mm^2 , using a ground screw and terminal to connect the ground cable which can ground the battery. The bolt locking torque is 2NM.

Step 2: Power connections between two batteries

Use power cable 1 to connect the negative pole (P- terminal) of battery pack A to the negative pole (P- terminal) of battery pack B, and use power cable 2 to connect the positive pole (P+ terminal) of battery pack A to the positive pole (P+ terminal) of battery pack B.

Step 3: Power connections of more than two batteries

Analogy derivation, more than two battery connections, connect the negative poles (P- terminal) between the battery packs and connect the positive poles (P+ terminal) between the battery packs.

Step 4: Connect the battery to the inverter power supply

After the battery is connected according to Steps 1-2, connect the negative pole (P- terminal) of the battery pack A and the BAT- terminal of the inverter with the power cable 3; connect the positive pole (P+ terminal) of the battery pack A and the BAT+ terminal of the inverter with the power cable 4.

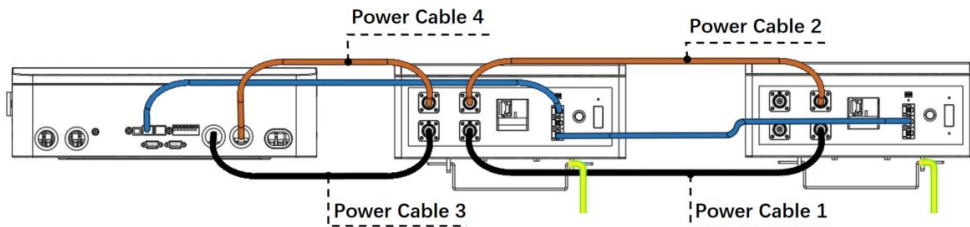
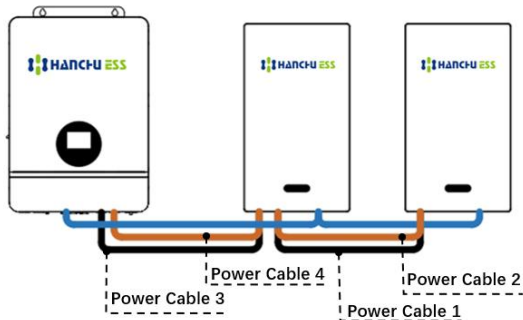

NOTE :

When the inverter is electrically connected, the inverter and batteries need to be powered off. Hear a sound locking into place as the cable connects to the terminal. It is forbidden to mix batteries of different brands, specifications and batches, otherwise it will cause system failure.

6. Communication Connection

Step 1: Connect the CAN communication line

Use the CAN communication cable to connect the inverter to the battery's CAN port.

Step 2: Connecting the RS485 communication line between two batteries

Use the RS485 communication line to connect the batteries in sequence through the RS485 port.

Step 3: Connecting the RS485 communication line to more than two batteries

Use the RS485 communication line to connect the adjacent batteries in sequence through the RS485 port.

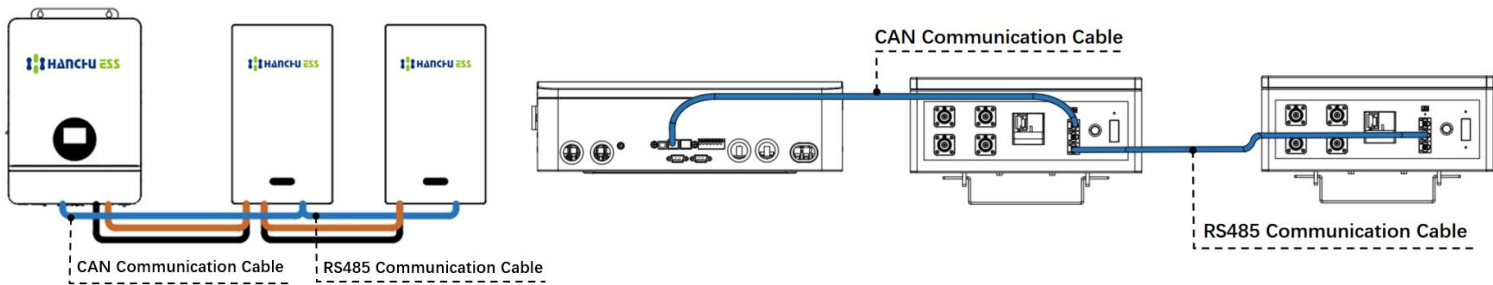

NOTE:

The connection between the inverter and the battery must be connected to the CAN communication port of the battery, otherwise, communication cannot be performed; similarly, the connection between the batteries must be connected to the RS485 port.

7. Equipment Debugging





Step 1: Primary dial setting: Setting the Primary DIP Address according to different communication protocols and inverter brands.

- Inverters using the **CAN** communication protocol need to set the Primary DIP Address according to the following table name of CAN communication.
- Inverters using the **RS485** communication protocol need to set the Primary DIP Address according to the following table name of RS485 communication.

NOTE:

- The battery directly connected to the inverter is the primary and the rest are subs. Only the primary needs to set the DIP address to select the protocol.

- When #5 is dialled to OFF status, protocol can be selected on Hanchu APP.

Primary unit	DIP ON	DIP OFF	Inverter brands	
			CAN communication	RS485 communication
	1	2	Pylon, Deye	GT, SMK
	2	1	Hanchu ESS, Luxpower	SRNE
	1,2	/	Victorn, SMA	Voltronic
	/	1,2	Protocols can be selected on Hanchu app	

Step 2: Equipment power on

Confirm gain that the cables are connected in the correct order and the connection is firm before starting the test.

- 1) First turn on the inverter.
- 2) Then press the power switch power on the battery pack in turn to turn on.
- 3) Next, turn on the circuit breaker switch on the battery.
- 4) Observe the status on the battery panel to ensure it is normal('RUN' green light flash, 'ALM' light off).

NOTE:

The shut down procedure is opposite to the startup process, first shut down the battery circuit breaker; Then shut down the power switch power on the battery. Final turn off the inverter. When the system starts, ensure the boot sequence of each equipment, otherwise it may cause pre-charging and trigger the circuit breaker protection fault.

Step 3: Confirm Address

- 1) When the system is used in parallel, it supports up to 16 batteries in parallel.
- 2) This battery supports automatic address recognition between the primary and subs, no need to manually set the DIP address.

Step 4: Inverter Protocol Selection

- 1) On the inverter, the battery manufacturer chooses the same protocol as the battery.
- 2) Then you should see the normal status information of the battery pack such as voltage, SOC, etc. from the inverter.

Contact

Hotline: +86-51088876668 / +86-51088865288

Service Email: service@hanchuess.com

Web: www.hanchuess.com